

HUMAX

EV CHARGING



EH-A01-A0704/GB
EH-A01-A0707/GB

EN

Install Guide

Welcome to HUMAX EV Charging

Overview	3
Safety Notice	3
Product Dimensions	3
Installation	4
Preparation	4
Tools Required	4
Installation Kit	4
Marking the Installation Site	5
Wall Mounting	5
Opening Cover	6
Working with Electricals	7
External Equipment	7
Device Built-in Protection	7
Wiring - Single Phase	8
External Wiring (RCBO)	9
External Wiring (RCCB)	9
Closing Cover	10
Commissioning the Charger	11
Humax EV charging app	11
Network - AP Mode	12
Humax Installer app	13
Load Balancing	13
Charge Mode	14
First Time Use (App)	14
Using the Charger	15
App Features	16
Light Sequence	17
Troubleshooting	18
Warranty	19
Certifications	19
Product Information	19
Support - Full User Manual	20



ATTENTION

IMPORTANT SAFETY NOTICE

Installations must only be carried out by qualified, registered electricians. This is a simple guide, and should not be used as a substitute for the full manual, which must be consulted before installation.

The cover of the charge point is only to be removed by qualified, registered electricians in accordance to local standards and regulations. This is a live electrical product. There is a risk of shock and potential electrical hazard. Please observe all warnings on the device and thoroughly read all documentation.

1. Cord extension sets are not allowed to be used.
2. Adaptors or conversion adaptors are not allowed to be used.

Product Dimensions

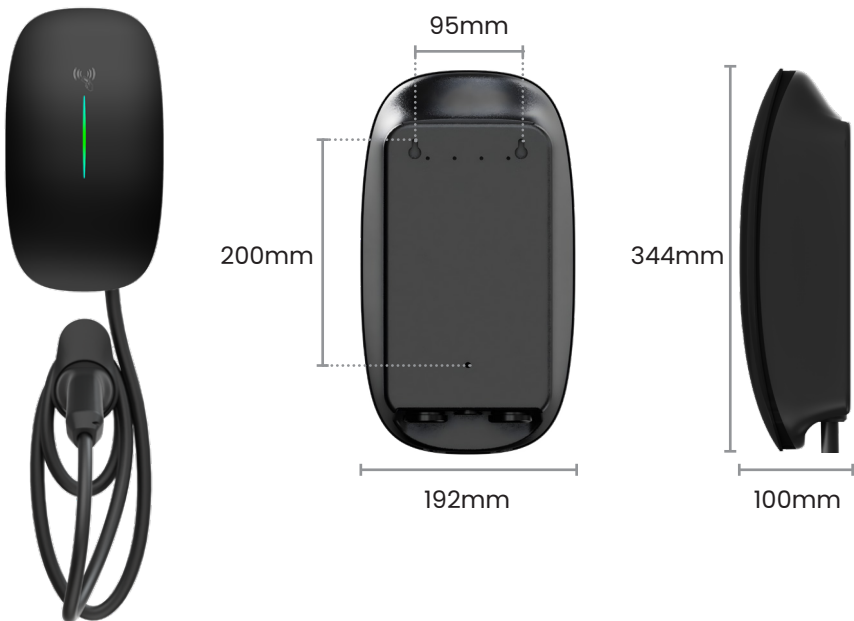

Tools Required



Multimeter
(AC/DC)

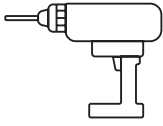

Electric
Power Drill



Screwdriver
(PH2 & PH3)



Insulated
Torque Wrench

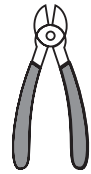

Diagonal
Pliers

+ Power supply cable - (single phase or three phase depending on regional requirement)

+ Smart meter - required for three phase 11kW installations

Installation Kit



6mm Ø Wall Plugs
x8



M4x32 Screws
x8



M4 Hex Allen Key
x1

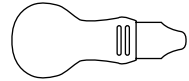

Enclosure Pry Tool
x1

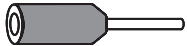

Wire-end Sleeves
x6



Cable Holder
x1



Rubber Seal Plug
x1

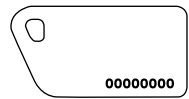

RFID Cards
x2



Cable Sheath
x1



Sheath Screws
x2

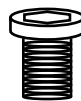

Hex Safety Screws
x2

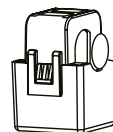

CT Clamp (7kW only)
x1

Marking the installation site

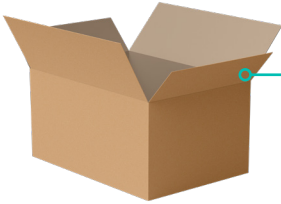

We've included an **install template** to help with mounting the unit.

Carefully cut out the template from the packaging box.

Please ensure a snug fit when mounting the charger on to the screw heads.

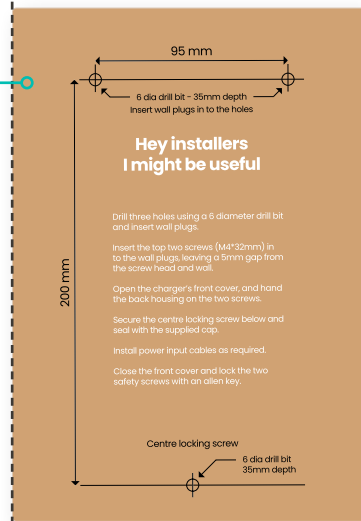

Wall Mounting Instructions

1. Position the EV charge point between 0.5 and 1.5 meters above ground level, ensuring adequate space on both sides of the charger for pry tool access.
2. Use a 6mm diameter drill bit to drill the marked three holes (35mm depth).
3. Insert wall plugs and drive the supplied screws in the top two holes leaving a 5mm gap from the screw head and wall (do not overtighten).
4. Open the charger's front cover, and hang the back of the housing on the screws.
5. Secure the centre locking screw and apply the rubber sealing cap.
6. Install the power input cables + CT wiring as required.

Before you proceed



HELP FROM THE SUPPORT HUB

Turn off the power before beginning installation. Please follow all instructions carefully.

Download the full User Manual and watch the installation videos available at the Support Hub: humaxcharging.com/supporthub

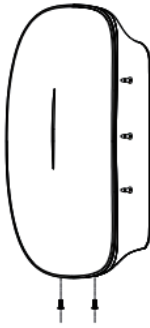

Step 1
Locate x2 Hex Safety Screws

We have removed these for your convenience and placed them inside the installation kit. Keep these aside until reassembly.

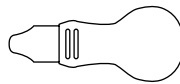
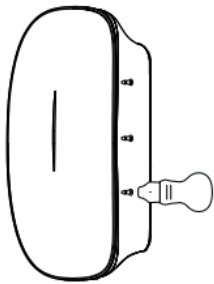

Step 2
Carefully pry marked edges

Use the enclosure pry tool to gently pry the marked points along the edge of both sides.

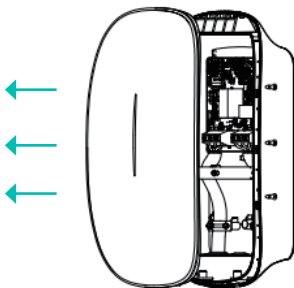

Step 3
Pull away to reveal internals

Gently pull the front panel away from the unit exposing the internal wiring.

External Equipment Required (RCD Protection)

We recommend a RCBO (Residual Current operated circuit Breaker with integral Overcurrent protection) or RCCB (Residual Current Circuit Breaker) + Circuit Breaker is installed.

A Type A RCBO with earth leakage protection of 30mA and 40A current rating must be installed separately in the consumer unit by the installer.

Specification for RCBO, RCCB + Circuit Breaker

Phase Type	Single-phase	Three-phase	
Output Power	7kW	11kW	22kW
Output Current	40A	20A	40A
Pole	2P	4P	
Tripping Characteristics	C		
Leakage Current Type	A		

Device Built-in Protection

PEN Fault Protection

The charge point is equipped with PEN Fault Protection and an automatic disconnection system which satisfies the requirements of BS7671:2018 Amendment 2:2022 722.411.4.1 (iv) the 18th Edition IET Wiring Regulations.

Residual DC Device

The charge point is equipped with 6mA DC Current Leakage Protection function which conducts an automated test for the 6mA DC (IEC 62955).

Type A + 6mA DC Leakage Current Protection

RCD Type A and appropriate equipment ensures disconnection of the power supply in case of DC fault current above 6 mA.



CAUTION: Certified RCBO should be installed upstream close to the charging station. All protection devices must comply with the appropriate technical specification according to local regulations.

Single Phase

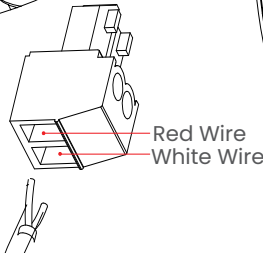
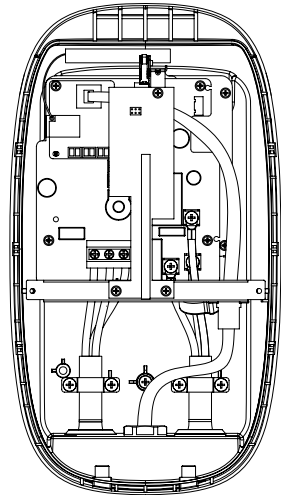
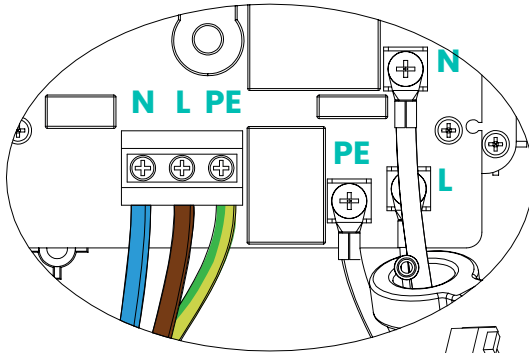

Red Wire
White Wire

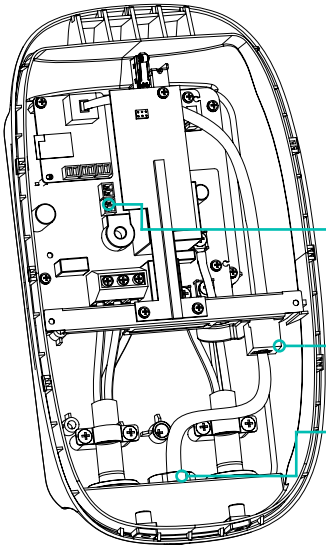

CT Port

RJ45 Ethernet Port

Tip: If you already have easy access to an outdoor rated Ethernet cable, feed this through the centre hole.

Reference Wiring Cable

We recommend using an install cable that carries: **Live, Neutral, Earth & Cat 5e** cabling to future proof Single Phase installs. 2 wires from Cat 5e cable can be used to extend the CT clamp up to 50m.



RCBO Connection

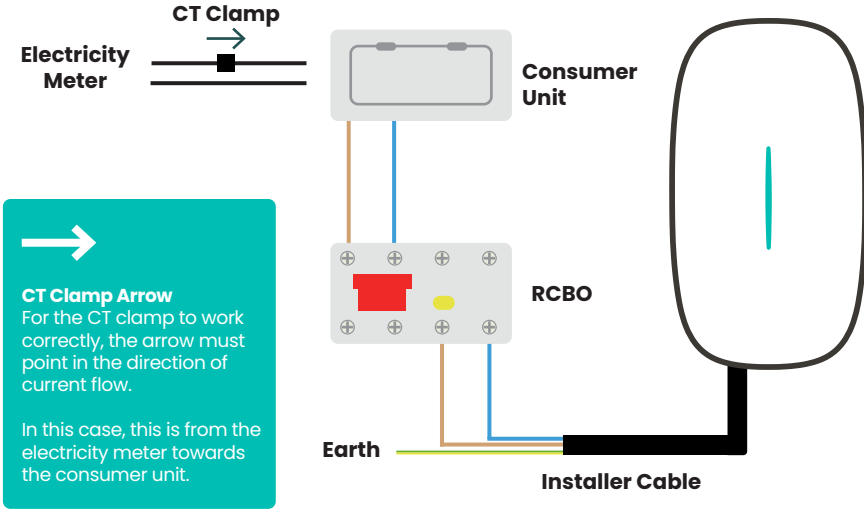

RCCB + Circuit Breaker Connection

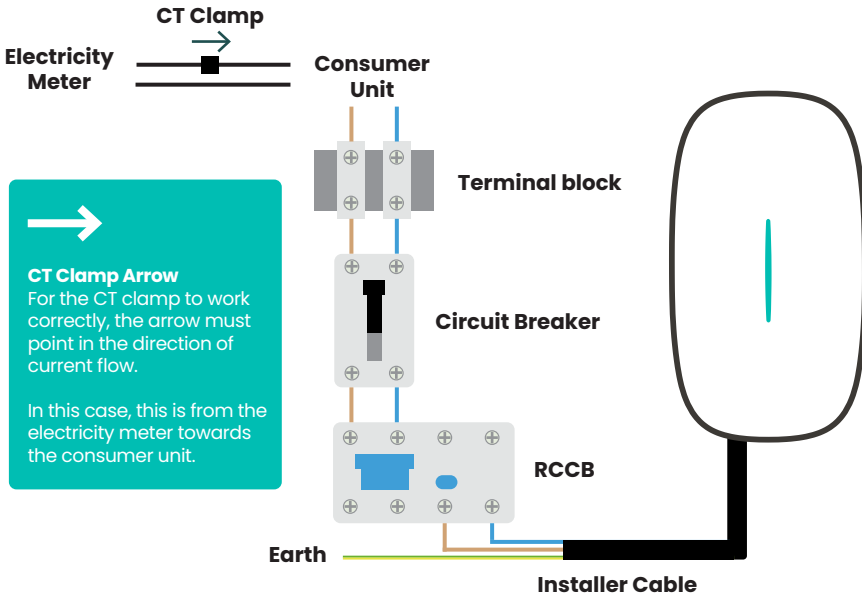

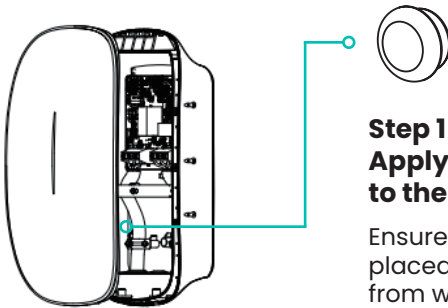

Step 1
Apply rubber sealing plug to the centre locking screw

Ensure the rubber seal is placed securely to protect from water ingress.

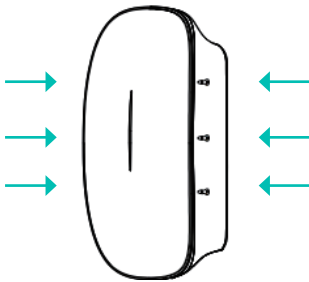

Step 2
Press firmly with even pressure

Ensure an audible click is heard around the pressure points when replacing the front panel.

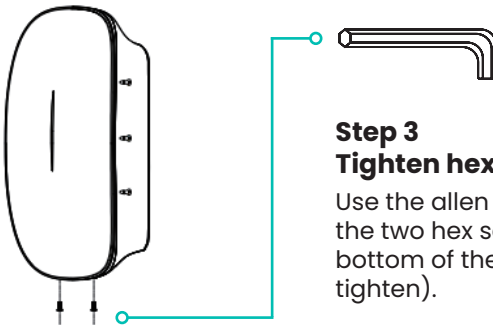

Step 3
Tighten hex safety screws

Use the allen key supplied to tighten the two hex safety screws at the bottom of the unit (do not over-tighten).

We've made it easy to set up the charger using one of the following:

1. **Humax EV charging app** – Download and install this app on the end-users device to complete the setup process.
2. **Network Access Point (AP Mode)** – Local hotspot connection with the charge point. Use this to configure the charge point and server details manually.
3. **Humax Installer App** – Installers should use this app and the transfer device ownership setting once setup is complete.

1. Humax EV charging App

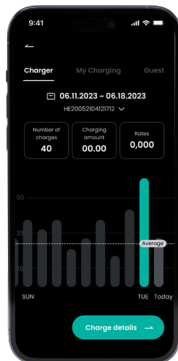
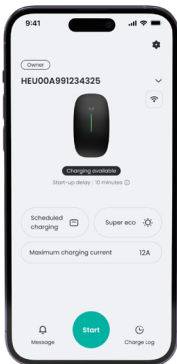

Setup Instructions

Download the **Humax EV charging** app (scan the QR code) and proceed with the on-screen instructions.



Tip: For full step-by-step details, please refer to the user manual available online at the Support Hub.

2. Network Access Point (AP Mode)

Access Point Mode (AP Mode) is a function that allows you to configure the network and server settings of the charger. The instructions below will guide you through how to connect to the charger and the server via any web browser.

Connect to the Charge Point WiFi Hotspot



Step 1 – Airplane Mode

We suggest placing your smartphone in to airplane mode and ensure WiFi is enabled.

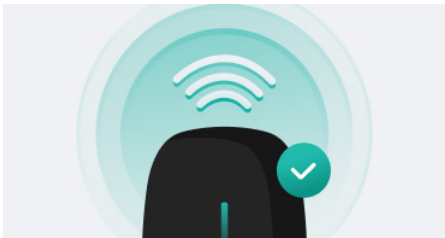

Step 2 – Power Reboot

Restart the power of the Charge Point and ensure the indicator light is flashing green.

Please note that the network configuration setting is only accessible 15 minutes after a power restart.

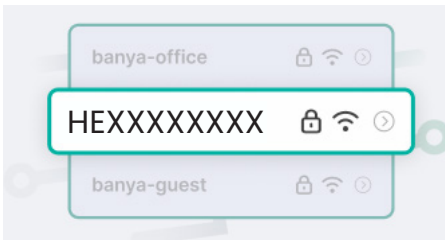

Step 3 – Charge Point WiFi Hotspot

On your smart phone, navigate to WiFi networks and select the charge point network, starting with HEXXX... (same as device Serial Number).

Input the default password:
admin123

Tip: Please reject automatic Wi-Fi network switching when the message appears for now.

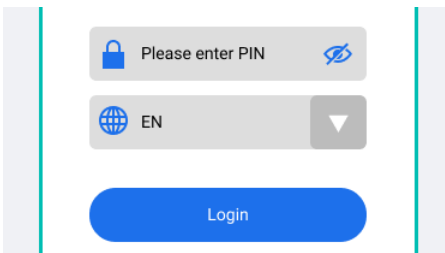

Step 4 – Connect to Charge Point

Open a web browser on your smartphone which should now be connected to the charger hotspot.

In the URL bar, type: 192.168.4.1

Input the 4-digit network pin which can be found on the charge point.

Tip: If the 192.168.4.1 webpage is not accessible, please reboot the charge point power and try again.

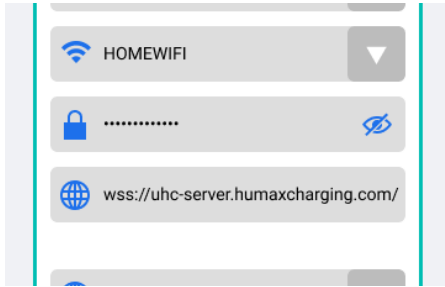

Step 5 – Network Settings

Tap the Network Settings button. Select the your home WiFi network and enter the password.

Enter the server address:

UK

wss://uhc-server.humaxcharging.com:443

Europe

wss://ehc-server.humaxcharging.com:443

Tip: Repeat Steps 3-4 to reconnect to the charge point hotspot.

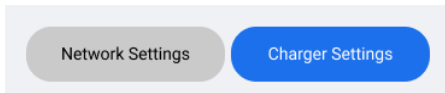

Step 6 – Charger Settings

Tap the Charger Settings button.

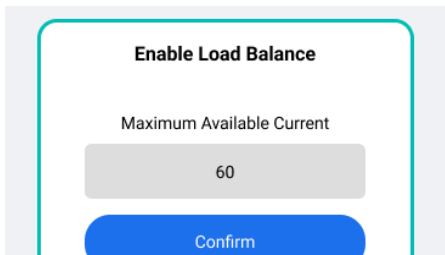

Switch Charging Modes:

- Network (RFID & App)
- Plug & Charge

Load Balancing:

Should be configured when a CT/ Smart Meter is connected. Check your household Main Fuse Rating, i.e. (60A, 80A, 100A) and enter this value. Save changes and reboot.

Tip: Repeat Steps 3-4 to reconnect to the charge point hotspot.

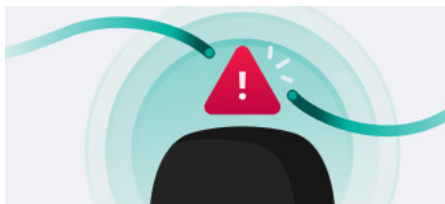

Step 7 – Verify Network Connectivity

If the WiFi strength is poor, please try a WiFi Extender or wired connection.

Verify The Following:

Wi-Fi Name – (your wifi router SSID)

Signal Strength – Excellent

Server Status – Connected

Network Status – Online

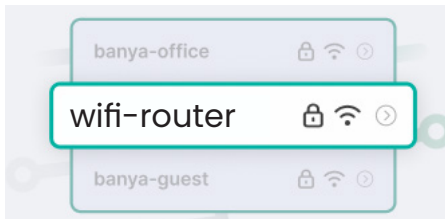

Step 8 – Switch back to local WiFi

Turn off airplane mode and connect back to the home WiFi network.

The charge point will restart and load in to the home network connection.

3. Humax Installer App

The **Humax Installer app** is to be used by Humax approved installers. If you have any trouble with your account, please contact our support team.

Search Device

Before starting the charger registration, please make sure that the charger is switched off.

Enter serial number

Enter PIN code

Load balancing

Please give the right information on the load balancing

Load balancing enable/disable

Enable Disable

CT clamp/meter

CT Clamp CT Meter

Max Input Current from Grid

Settings

Customer's WiFi detail

WiFi name (SSID)

Password

Server URL

Max charge current (1-32)

Transfer ownership

Device has successfully been connected. You can now safely transfer ownership of this device to the customer.

Enter customer details

Email address

First name

Last name

Setup Instructions

Download the **Humax Installer app** (scan the QR code) and proceed with the on-screen instructions.



1. Sign In/Up

Approved installers can login using their assigned email address.

2. Search Device

Scan the device serial number via Bluetooth.

3. Settings - WiFi/Server

Enter Wi-Fi and Server details, whilst setting the Max Charge Current.

4. Load Balancing

Configure load balancing and CT details based on household/grid.

5. Transfer Ownership

Enter the end user's email address to transfer the charge point.

Tip: For full step-by-step details, please refer to the user manual available online at the Support Hub.

Plug and Charge

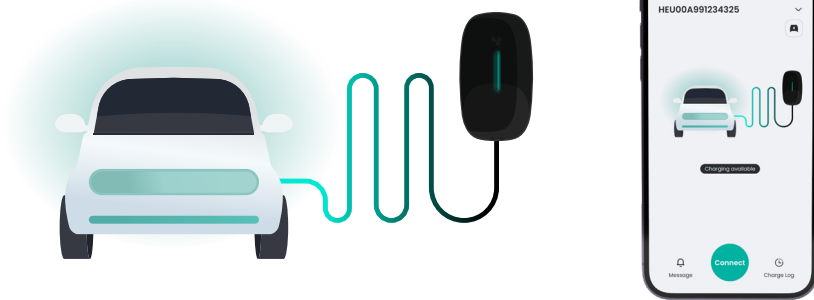

Simply plug the charging cable into your EV to start charging. To stop charging, use your car to unlock the charger cable from the EV and unplug. To enable, change **charging mode** to **Plug and Charge** from **Humax EV charging** app.

Tip: Plug & Charge prioritises convenience. This mode should only be activated if your charge point and EV is parked in a private and gated residence.

RFID card

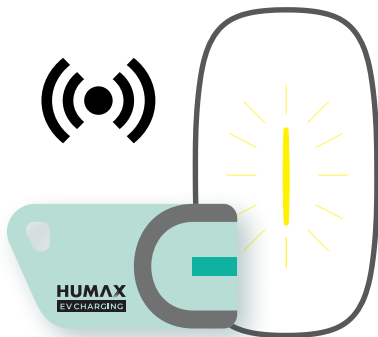

Alternatively, activate the charger from the unit by swiping the RFID card over the reader indicator.

To stop charging, simply swipe over the reader indicator again.

A yellow pulse indicates a successful card swipe.

RFID Card (Network) requires an internet connection. An activation request is securely sent to the server which enables the charging system.

Tip: This mode should be activated if your charge point and EV is parked in an open or ungated residence.

RFID cards can be registered through the **Humax EV charging** app.

Humax EV charging app

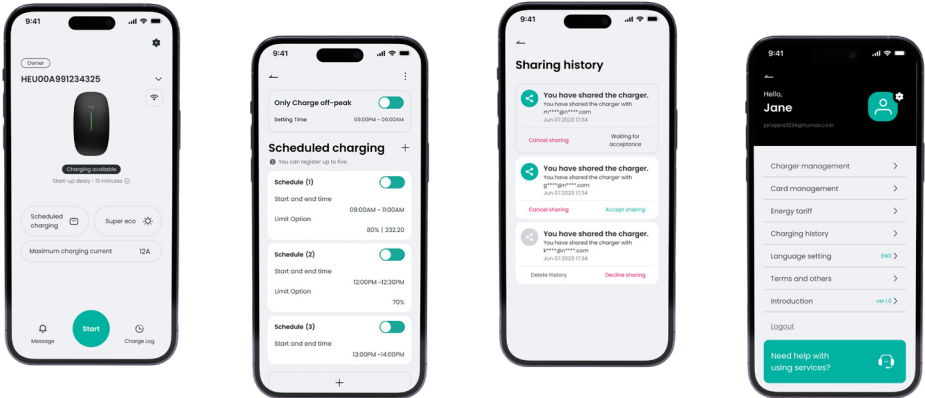

Home

The home screen is where you can control your charger and monitor energy usage. Just plug the charger into your vehicle and tap 'Start'. Alternatively, swipe your RFID card to activate charging.

Schedules

Charge when local energy demand is low. Set this up along with your own energy management preferences from the 'Scheduled charging' tab.

Off-peak Charging

Your charge point will come with a pre-configured schedule to encourage charging during lower energy consumption times (11:00 - 16:00, 22:00 - 8:00).

Randomised Delay

To prevent problems with the national electricity system when many devices turn on or off at once, a Randomised Delay of up to 10 mins is required when charging starts or stops. You can opt out of this at any time in the app.

Share

Grant access to your home charger with friends and family. Register users inside Manage Users or open the Share options to instantly send a message allowing temporary access.

Support

After installation, we take care of the warranty registration process for you. Should you experience any issues, just visit the Support Hub.

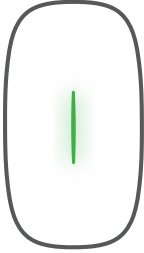

Ready to charge

Green pulses every 3 seconds indicates the charger is in standby and ready to use.

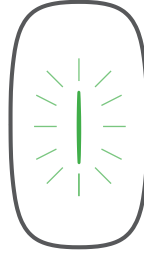

Charging in progress

Green blinking every second indicates the EV is charging.

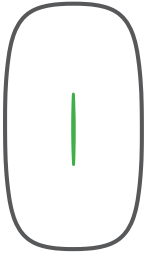

Fully charged

Solid green indicates the EV is fully charged.

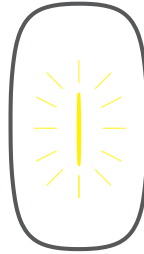

RFID card swipe

Yellow pulse indicates a successful RFID card swipe.

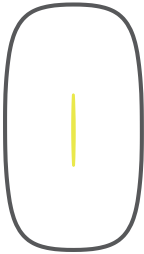

Warning

Solid yellow light indicates a warning. Please check the full user manual for troubleshooting tips.

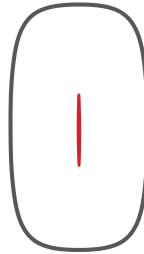

Faults

Solid or blinking red lights indicates a fault. Please contact the support team.



HELP FROM THE SUPPORT HUB

Videos, troubleshooting and FAQs are available at: humaxcharging.com/supporthub

Email: uk.support@humaxcharging.com

Possible Cause	LED Indicator Status
Warning	Solid yellow light
Relay adhesion	Solid red light
Leakage current fault	Flashing red, 1 time, 3S off
CP fault	Flashing red, 2 times, 3S off
Over current fault	Flashing red, 3 times, 3S off
Input polarity reverse	Flashing red, 4 times, 3S off
Leakage current loop abnormal	Flashing red, 5 times, 3S off
Input terminal overtemperature	Flashing red, 6 times, 3S off
Relay overtemperature	Flashing red, 7 times, 3S off
Over/Under voltage fault	Solid yellow 2S, flashing red 1 time
Over/Under frequency fault	Solid yellow 2S, flashing red 2 times
Meter comm. abnormal	Solid yellow 2S, flashing red 3 times
Smart meter comm. abnormal	Solid yellow 2S, flashing red 4 times
CT fault	Solid yellow 2S, flashing red 5 times
Charging connector lock abnormal	Solid yellow 2S, flashing red 6 times
Charging connector current abnormal	Solid yellow 2S, flashing red 7 times

Tip: For full troubleshooting and maintenance details, please refer to the User Manual available online at the Support Hub.



HELP FROM THE SUPPORT HUB

Videos, troubleshooting and FAQs are available at: humaxcharging.com/supporthub

Email: uk.support@humaxcharging.com

Humax provides a warranty for this product against any defects in materials and craftsmanship for a duration of three years from the date of installation. To uphold our limited warranty, proper installation is essential, following Humax's guidelines, adhering to relevant regulations, and performed by a certified electrician.

Throughout this period, Humax will, at its discretion, repair or replace any faulty product at no cost to the owner. Replaced items or mended components will carry a guarantee for the remaining time of the original warranty, or six months, whichever is longer.

The landscape of electric vehicles is in constant evolution, and even seemingly identical manufacturers, models, and years can encompass diverse battery and software setups. We acknowledge the potential frustration stemming from this variability, which sometimes can be attributed to the vehicle and its manufacturer. To address this, we've developed a solution that enables our company to make remote adjustments and updates to chargers, ensuring they operate optimally and in sync with the latest electric vehicle developments.

It's important to note that this limited warranty does not cover defects arising from accidents, misuse, inadequate maintenance, or normal wear and tear. Any client-initiated part replacements or integrations will be considered improper usage. Except where prohibited by applicable law, the conditions outlined in this limited warranty do not exclude, limit, or alter the mandatory statutory rights related to product sales. If you suspect a defect in your product, please contact us for guidance on where to send or bring it for repair.

Please retain your purchase receipt as evidence of your transaction, as it will be necessary to validate any warranty-related repairs in the future. You can find the product code and serial number on the side of the product with the barcode label.

Certification Standards

EN IEC 62311:2020	EN IEC 61851-1:2019
EN 300328 V 2.2.2:2019	EN IEC 61851-21-2:2021
EN 300330 V 2.1.1:2017	BS EN IEC 61000-6-1:2019
EN 301489-1 V 2.2.3:2019	BS EN IEC 61000-6-3:2021
EN 301489-3 V 2.1.1:2019	BS EN IEC 61851-1:2019
EN 301489-17 V3.2.0:2017	BS EN IEC 61851-21-2:2021
EN IEC 61000-6-1:2019	IEC 62955:2018
EN IEC 61000-6-3:2021	BS 7671:2018/A1:2020/A2:2022

Product Information

Model: EH-A01-A070X/GB ('X' means a number, from 1 to 7, stand for the cable length)

Rated Voltage: 230V AC (1P+N+PE)

Rated Current: 32A

Frequency: 50Hz

Use Environment: Indoor/outdoor

Operating Temperature: -30°C to +50°C

Ingress Protection: -Enclosure IP65, Vehicle connector IP55

Pollution Degree: PD3

Device Type: Class I

Charging Mode: Mode 3

Grid Type: TN

Support Hub



Access the full user manual, installation videos and more

Contact Us

0344 318 8800

uk.support@humaxcharging.com

www.humaxcharging.com/uk

The Mille, Great West Road,
Brentford, TW8 9DW, UK

Mon-Fri 9am-5:30pm

User App



Download the Humax
EV charging app

Installer App



Download the Humax
Installer app

Your installer must utilize the installer app and register the installation to initiate the Humax warranty

Fix PIN sticker here
or inside your fuse box

HUMAX

v1.0 Please note this Installation Guide is subject to change.
For the latest versions of all supporting material, please visit the Support Hub.